

Model: DC-638

Extruded Aluminum Louver - Mounting Option #4 Shown

Miami-Dade County, FL
NOA No: 09-0916.02
Expiration Date: 1/6/2015
FL#: 6147

Application:

DC-638 is an extruded louver designed specifically to meet the following Miami-Dade County test requirements and protocols:

- **TAS 201-94** (Large Missile Impact Test)
- **TAS 202-94** (Uniform Static Air Pressure Test)
- **TAS 203-94** (Cycle Wind Loading Test)

Based on single section testing of an 84"w x 120"h sample with a maximum design load pressure of 160-psf.

Standard Specifications:

Frame: Heavy gauge 6" x .125" thick 6063T5 extruded aluminum. **Flanged Bottom Sill.**

Blade: Drainable design .125" thick 6063T5 extruded aluminum, mechanically fastened and welded to jambs on backside of blade, set on 38 degree angles. Blades are spaced at 4.75" (Bottom blade opening varies).

Birdscreen: Standard .0516" x 3/4" flattened expanded aluminum.

Aluminum Angle: 2" x 2" x 3/16"

10 ga. Aluminum Sleeve with Flange: 12" long min. - 24" long max.

Minimum size:

12"w X 12"h

Maximum Size:

84"w x 120"h Single Section.
Unlimited width x 120"h sectional.

Options:

- Insect Screen
- Approved Wedge Anchors
- Mill Finish (standard)
- Enamel Finish
- Kynar Finish
- Anodized Finish
- Powder Coating (Other Finishes Available)

Features:

- Louver may be used in approved masonry or wood structure walls.
- 57% Free Area
- Published performance ratings based on testing in accordance with AMCA Standard 500-L

Note: All DC-638 louvers are built 1/2" under size both directions unless ordered actual size.

LEADER

Dampers & Louvers

P.O. Box 40913
Nashville, TN 37204
www.leaderindustries.com
A Division of Leader Industries, Inc.

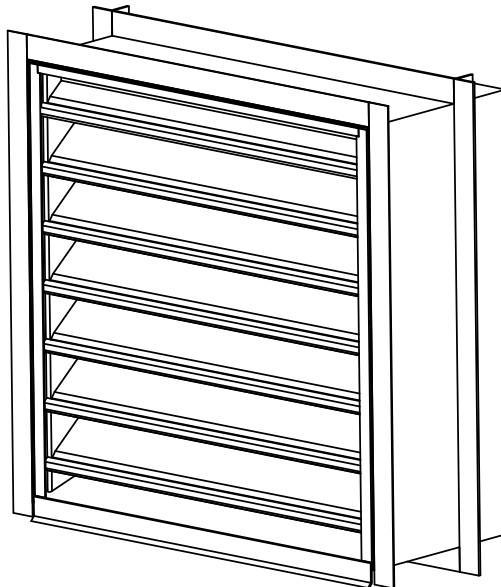

Max Wind Load
+/- 160 psf

Mounting
Option
#4

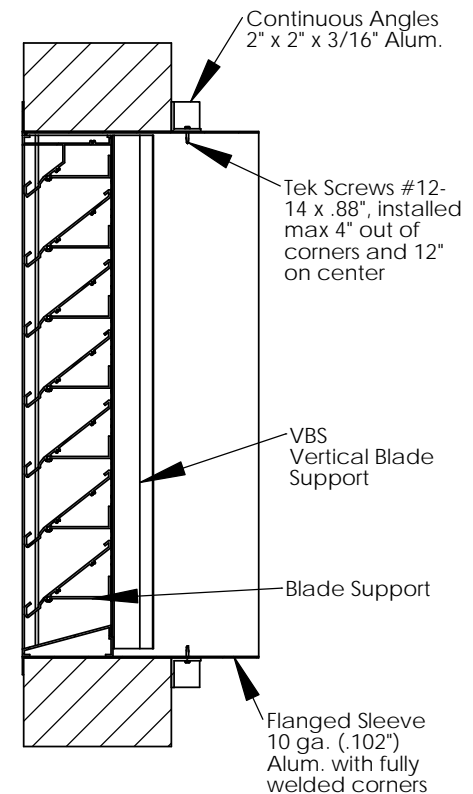

57% Free Area



Water Penetration Chart

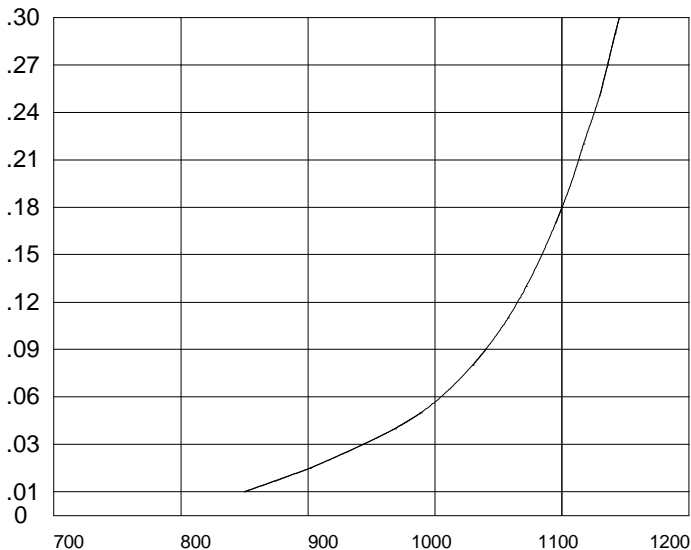

Water Penetration beginning point is 845.4 fpm
 Free Area Velocity.
 Data applies to test size of 48" x 48" DC-638 sample.
 Test duration was 15 min.

Leader Industries, Inc. certifies that the model DC-638 shown herein is licensed to bear the AMCA Seal. The ratings shown are based on tests and procedures performed in accordance with AMCA Publication 511 and comply with the requirements of the AMCA Certified Ratings Program. The AMCA Seal applies to Water Penetration and Air Performance ratings only.

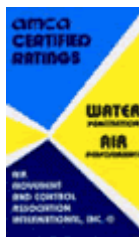

Pressure Drop

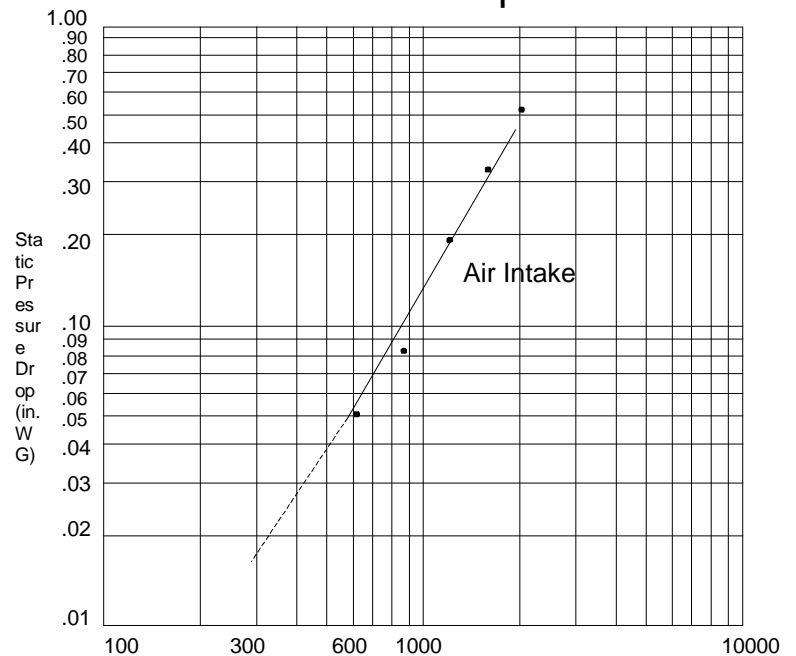

Air Velocity in feet per minute

Ratings do not include the effect of bird screen
 The Figure 5.5 test is based on a 48" x 48" sample size

DC-638 Specifications

Louvers meeting the following specifications shall be furnished and installed where shown on the plans and or schedules. Louvers shall be stationary type with horizontal drainable blades in a 6 in. deep frame. Louvers shall conform to South Florida Building Code, (Miami Dade County), Protocols: PA 201-94, PA 202-94, and PA 203-94 based on a maximum design load of 160 lbs./sq. ft. (Corresponds with a 250 mph wind), when mounted within a concrete, masonry block or structural steel framed opening. Louver blade and frame materials to be 0.125 in. thick 6063T5 extruded aluminum. Louver blades shall be positioned at 38° angles on approximately 4.75 in. centers. Louver blades shall be both mechanically fastened with Tek Screws and welded to the frame. All welding to louver blades shall be on backside to maintain aesthetic appearance. Louver sections for openings larger than 84 in. wide shall have factory supplied mullions contained within the jamb for smooth uninterrupted appearance. Louver performance data shall be licensed under the AMCA Certified Rating Program, and shall bear the AMCA Certified Ratings Seal. This licensed performance data shall include airflow pressure loss and water penetration, and shall demonstrate performance equal to or better than the Leader model specified.



Model DC-638 Extruded Aluminum Louver

CFM and Free Area Selection Chart

		Louver Width (in.)												
		12	18	24	30	36	42	48	54	60	66	72	78	84
Louver Height (in.)	12	0.36 306	0.59 502	0.82 697	1.05 893	1.28 1088	1.52 1292	1.75 1488	1.98 1683	2.21 1879	2.44 2074	2.67 2270	2.91 2474	3.14 2669
	18	0.64 544	1.06 901	1.48 1258	1.89 1607	2.31 1964	2.73 2321	3.14 2669	3.49 2967	3.98 3383	4.39 3732	4.81 4089	5.23 4446	5.64 4794
	24	0.84 714	1.38 1173	1.92 1632	2.46 2091	3.01 2559	3.55 3018	4.09 3477	4.63 3936	5.18 4403	5.72 4862	6.26 5321	6.80 5780	7.35 6248
	30	1.12 952	1.85 1573	2.58 2193	3.30 2805	4.03 3426	4.76 4046	5.48 4658	6.21 5279	6.94 5899	7.66 6511	8.39 7132	9.12 7752	9.85 8373
	36	1.41 1199	2.32 1972	3.23 2746	4.14 3519	5.05 4293	5.97 5075	6.88 5848	7.79 6622	8.70 7395	9.61 8169	10.53 8951	11.44 9724	12.35 10498
	42	1.69 1437	2.78 2363	3.88 3298	4.98 4233	6.07 5160	7.17 6095	8.26 7021	9.36 7956	10.45 8883	11.55 9818	12.64 10744	13.74 11679	14.83 12606
	48	1.86 1581	3.07 2610	4.28 3638	5.49 4667	6.70 5695	7.90 6715	9.11 7744	10.32 8772	11.53 9801	12.74 10829	13.95 11858	15.15 12878	16.36 13906
	54	2.17 1845	3.57 3035	4.98 4233	6.38 5423	7.79 6622	9.20 7820	10.60 9010	12.01 10209	13.41 11399	14.82 12597	16.23 13796	17.63 14986	19.04 16184
	60	2.45 2083	4.04 3434	5.63 4786	7.22 6137	8.81 7489	10.40 8840	11.99 10192	13.58 11543	15.17 12895	16.76 14246	18.35 15598	19.94 16949	21.53 18301
	66	2.74 2329	4.51 3834	6.28 5338	8.06 6851	9.83 8356	11.61 9869	13.38 11373	15.15 12878	16.93 14391	18.70 15895	20.48 17408	22.25 18913	24.03 20426
	72	2.93 2491	4.83 4106	6.74 5729	8.64 7344	10.54 8959	12.44 10574	14.34 12189	16.25 13813	18.15 15428	20.05 17043	21.95 18658	23.86 20281	25.76 21896
	78	3.21 2729	5.30 4505	7.38 6273	9.47 8050	11.55 9818	13.64 11594	15.72 13362	17.81 15139	19.89 16907	21.98 18683	24.06 20451	26.15 22228	28.23 23996
	84	3.50 2975	5.77 4905	8.04 6834	10.31 8764	12.57 10685	14.84 12614	17.11 14544	19.38 16473	21.65 18403	23.92 20332	26.19 22262	28.46 24191	30.73 26121
	90	3.78 3213	6.23 5296	8.69 7387	11.14 9469	13.59 11552	16.05 13643	18.50 15725	20.95 17808	23.40 19890	25.86 21981	28.31 24064	30.76 26146	33.22 28237
96	3.98 3383	6.56 5576	9.14 7769	11.72 9962	14.30 12155	16.87 14340	19.45 16533	22.03 18726	24.61 20919	27.19 23112	29.77 25305	32.35 27498	34.93 29691	
102	4.26 3621	7.02 5967	9.79 8322	12.55 10668	15.32 13022	18.08 15368	20.84 17714	23.61 20069	26.37 22415	29.13 24761	31.90 27115	34.66 29461	37.43 31816	
108	4.54 3859	7.49 6367	10.44 8874	13.39 11382	16.33 13881	19.28 16388	22.23 18896	25.18 21403	28.12 23902	31.07 26410	34.02 28917	36.97 31425	39.91 33924	
114	4.74 4029	7.82 6647	10.90 9265	13.97 11875	17.05 14493	20.12 17102	23.20 19720	26.28 22338	29.35 24948	32.43 27566	35.51 30184	38.58 32793	41.66 35411	
120	5.02 4267	8.28 7038	11.54 9809	14.80 12580	18.06 15351	21.31 18114	24.57 20885	27.83 23656	31.09 26427	34.35 29198	37.61 31969	40.86 34731	44.12 37502	

This table has been developed to assist in application and selection of these louvers. Two numbers are shown for each louver size. The top number represents the sq. ft. of louver free area for each louver size. The bottom number shows CFM of air flow permitted when selecting an intake louver at the point of zero water penetration.

Pressure drop when using this selection guide for an intake louver will be .055 in. W.G. Louvers may be selected at other operating points on the performance curves if desired using the formula:
 $CFM = \text{Free Area (sq. ft.)} \times \text{Free Area Velocity (FPM)}$

Free Area Chart DC-638

		W I D T H I N C H E S												
		12	18	24	30	36	42	48	54	60	66	72	78	84
H E I G H T I N C H E S	12	0.36	0.59	0.82	1.05	1.28	1.52	1.75	1.98	2.21	2.44	2.67	2.91	3.14
	18	0.64	1.06	1.48	1.89	2.31	2.73	3.14	3.49	3.98	4.39	4.81	5.23	5.64
	24	0.84	1.38	1.92	2.46	3.01	3.55	4.09	4.63	5.18	5.72	6.26	6.80	7.35
	30	1.12	1.85	2.58	3.30	4.03	4.76	5.48	6.21	6.94	7.66	8.39	9.12	9.85
	36	1.41	2.32	3.23	4.14	5.05	5.97	6.88	7.79	8.70	9.61	10.53	11.44	12.35
	42	1.69	2.78	3.88	4.98	6.07	7.17	8.26	9.36	10.45	11.55	12.64	13.74	14.83
	48	1.86	3.07	4.28	5.49	6.70	7.90	9.11	10.32	11.53	12.74	13.95	15.15	16.36
	54	2.17	3.57	4.98	6.38	7.79	9.20	10.60	12.01	13.41	14.82	16.23	17.63	19.04
	60	2.45	4.04	5.63	7.22	8.81	10.40	11.99	13.58	15.17	16.76	18.35	19.94	21.53
	66	2.74	4.51	6.28	8.06	9.83	11.61	13.38	15.15	16.93	18.70	20.48	22.25	24.03
	72	2.93	4.83	6.74	8.64	10.54	12.44	14.34	16.25	18.15	20.05	21.95	23.86	25.76
	78	3.21	5.30	7.38	9.47	11.55	13.64	15.72	17.81	19.89	21.98	24.06	26.15	28.23
	84	3.50	5.77	8.04	10.31	12.57	14.84	17.11	19.38	21.65	23.92	26.19	28.46	30.73
	90	3.78	6.23	8.69	11.14	13.59	16.05	18.50	20.95	23.40	25.86	28.31	30.76	33.22
	96	3.98	6.56	9.14	11.72	14.30	16.87	19.45	22.03	24.61	27.19	29.77	32.35	34.93
	102	4.26	7.02	9.79	12.55	15.32	18.08	20.84	23.61	26.37	29.13	31.90	34.66	37.43
108	4.54	7.49	10.44	13.39	16.33	19.28	22.23	25.18	28.12	31.07	34.02	36.97	39.91	
114	4.74	7.82	10.90	13.97	17.05	20.12	23.20	26.28	29.35	32.43	35.51	38.58	41.66	
120	5.02	8.28	11.54	14.80	18.06	21.31	24.57	27.83	31.09	34.35	37.61	40.86	44.12	

DC-638 Selection and Examples

Example 1:

Airflow given as 10000 cfm – select louver size.

- A. Determine louver free area by dividing airflow by free area velocity (do not exceed 845 fpm on intake louver application).

$$\frac{10000 \text{ cfm}}{\text{Airflow}} \div \frac{845 \text{ fpm}}{\text{Free Area Velocity}} = \frac{11.84 \text{ ft.}^2}{\text{Required Louver Free Area}}$$

- B. Select a louver with at least the required free area from **Free Area Chart** above. Louver size = **54" W x 54" H**
 12.01 ft.^2 free area
 833 fpm free area velocity (10000 cfm ÷ 12.01 ft.² F.A.)

- C. Check the pressure drop of the selected louver at the given airflow (pressure drop chart on page 2).
 ΔP at $833 \text{ fpm} = .08 \text{ in. wg}$
Free Area Velocity Pressure Drop

Example 2:

Louver size given as 48" x 48" – determine maximum intake airflow.

- A. Use **Free Area Chart** to determine Free Area = 9.11 ft.^2

- B. Multiply Free Area x Free Area Velocity (Do not exceed 845 fpm on intake louver applications).
 $9.11 \text{ ft.}^2 \times 845 \text{ fpm} = 7702 \text{ cfm}$
Free Area Free Area Velocity Maximum Airflow

- C. Check the pressure drop of the selected louver at the given airflow (**Pressure Drop Chart** on page 2).
 ΔP at $845 \text{ fpm} = .08 \text{ in. wg}$
Free Area Velocity Pressure Drop

Installation Instructions

Leader Model DC-638

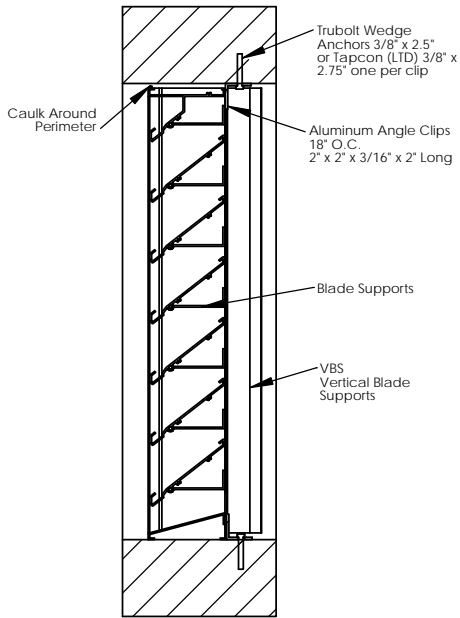

Fig. 1 - DC-638-1

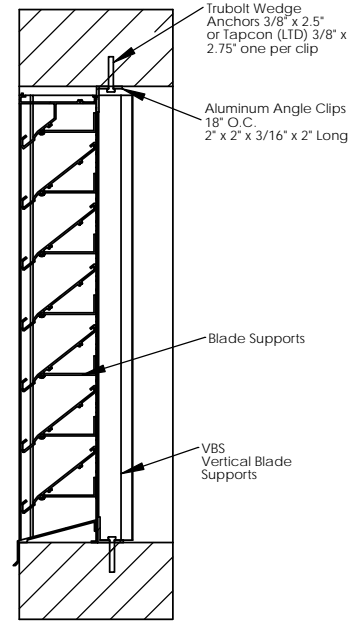

Fig. 2 - DC-638-2

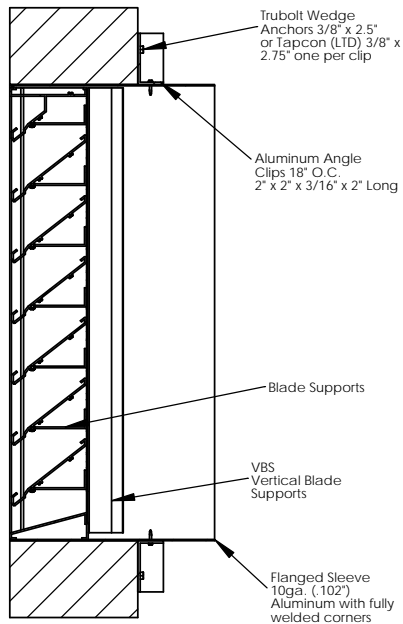

Fig. 3 - DC-638-3

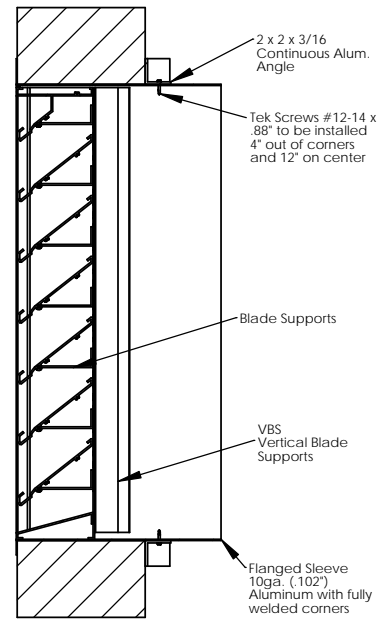

Fig. 4 - DC-638-4

See following page for installation details:



P.O. Box 40913
 Nashville, TN 37204
www.leaderindustries.com
 A Division of Leader Industries, Inc.

Installation Instructions for Leader Model DC-638, (cont.):

Models DC-638-1, DC-638-2:

1. **Anchoring into Concrete or Masonry:** See **Fig. 1 & 2**, Model **DC-638-1, DC-638-2** for detailed instructions.
2. Install louver into opening. Shim as required at each set of installation anchors using load-bearing shims. Max allowable shim stack to be $\frac{1}{4}$ ". Use shims where space greater than $\frac{1}{16}$ " is present. Fasten angle clips to DC-638-1 louver with two (2) # 12-14 x .88 TEK screws. Use $\frac{3}{8}$ " Dia. Trubolt wedge anchors of sufficient length to achieve min. of 3" embedment into concrete or masonry with min. 3" edge distance.
3. **Anchoring into Wood Frame Substrate:** Use $\frac{7}{16}$ " Dia. Lag Screws of sufficient length to achieve $3\frac{1}{2}$ " min. embedment into wood framing with min. 3" edge distance.
4. Seal louver opening to perimeter using backing rod and sealant (by others).
For correct anchor spacing according to opening size, and for more detailed drawing see NOA #09-0916.02.

Model DC-638-3

1. **Anchoring into Concrete or Masonry:** See **Fig. 3** Model **DC-638-3** for detailed instructions.
2. Install louver into opening. Shim as required at each set of installation anchors using load-bearing shims. Max allowable shim stack to be $\frac{1}{4}$ ". Use shims where space greater than $\frac{1}{16}$ " is present. Fasten continuous angle to DC-638-3 louver sleeve with # 12-14 x .88 TEK screws, spacing as follows: **Head and Sill** - at 8" from corners, 13" O.C. **Jambs** - at 6" from corners, 18" O.C. Attach continuous angle, (with same fastener spacing as TEK screws), to concrete or masonry using $\frac{3}{8}$ " Dia. Trubolt wedge anchors of sufficient length to achieve min. of 3" embedment into concrete or masonry with min. 3" edge distance.
3. **Anchoring into Wood Frame Substrate:** Use $\frac{7}{16}$ " Dia. Lag Screws of sufficient length to achieve $3\frac{1}{2}$ " min. embedment into wood framing with min. 3" edge distance.
4. Seal louver opening to perimeter using backing rod and sealant (by others). For more detailed drawings and instructions see NOA #09-0916.02.

Model DC-638-4

1. Install louver into opening. Shim as required using load-bearing shims. Max allowable shim stack to be $\frac{1}{4}$ ". Use shims where space greater than $\frac{1}{16}$ " is present.
2. Attach Sleeve to the continuous angle with #12-14 x .88 TEK screws. Spacing as follows: **Head and Sill** - at 8" from corners, $13\frac{1}{2}$ " O.C. **Jambs** – at 6" from corners, 12" O.C. Trubolt wedge anchors or lag screws are not used for this configuration.
3. This configuration of the DC-638 Louver System is not mechanically fastened to the substrate.
4. Seal louver opening to perimeter using backing rod and sealant (by others). For more detailed drawings and instructions see NOA #09-0916.02.

DC-638 Series Hurricane Louver Specifications

All Severe Duty Hurricane Louvers shall have been tested and successfully passed the Miami-Dade County requirements as listed below for impact resistance, static and cyclic air pressure testing as set forth by the Miami-Dade County Building Code Compliance Office and carry the appropriate NOA seal.

- A. Impact Test: TAS 201 Large Missile
- B. B. Uniform Static Pressure Test: TAS 202
- C. Cyclic Wind Pressure Load Test TAS 203 with a Specimen Design Pressure (DP) rating not less than 150 pounds per square foot.

The **DC-638** six-inch deep Hurricane Louvers have been tested and certified for air performance and water penetration and are in compliance with the requirements of **AMCA Standard 500** and carry the appropriate seals.

The **DC-638** six inch deep Hurricane Louvers is a drainable blade design utilizing integral water drains concealed within the louver jambs to carry water away from the outer face. Louver Blades, Jamb Headers and Sills shall be constructed of a minimum .125 thick extruded 6063 T5 aluminum alloy. A .0516 thick x 3/4" flattened expanded aluminum bird screen attached to the rear of the louver is standard.

The **DC-638** Mounting Method 4, six inch deep Hurricane Louvers are supplied mounted in a factory sleeve (12" minimum up to a 24" maximum length) with fully welded corners constructed of a minimum of .101" thick aluminum. Factory sleeves incorporate a standard formed 1.5" (2" optional) wide mounting flange located on the front side of the louver. The factory provided retaining angles are positioned on the face of the inside wall and attached to the sleeve by means of screws. No drilling of the support walls or building structure is necessary to secure the louver in the prepared opening. All screws shall be caulked after installation to obtain a watertight seal.

All Severe Duty Hurricane Louvers shall incorporate factory provided weep openings in the bottom corners of the louver assembly to drain any water carry over due to excessively high wind driven rain.

Acceptable Manufacturers

1. Leader Dampers & Louvers Model **DC-638**, Mounting Methods 1, 2, 3 or 4 as applicable.